

GAS GRIDDLE 450mm

GP513-B, GP513-CB, GP513-LS

- Heavy-duty thermostatic gas griddle
- 20mm thick griddle plate
- Ribbed plate option
- Mirror chromed plate option
- Top weld sealed plates
- 40MJ thermostatic burner system
- 2 models of base unit
- Rear rollers
- Stainless steel exterior
- Easy clean
- Easy service
- Fully modular



GP514-LS

Overall Construction

Griddle

- 20mm thick machined top plates standard
- Optional full width ribbed plate section
- Optional full width mirror finish hard chrome plate
- 2.5mm thick 304 stainless steel splash guards sides and rear
- 40MJ single 3 bar even heat burner with single thermostatic control
- Full pilot and flame failure protection with piezo ignition
- Welded hob surround with 1.5mm 304 stainless steel bull nose
- Side panels 1.2mm 304 stainless steel
- Splashback 1.2mm 304 stainless steel
- Vitreous enamelled control panel
- Stainless steel grease drawer
- Overlapping finish at front and rear of plate for easy clean

Bench mount (supplied as -B model)

- Four 63mm dia. heavy-duty 1.2mm 304 stainless steel bench legs with adjustable feet.
- Adjustable height 80mm – 105mm

Cabinet base (supplied as -CB model)

- Fully modular for matched suite finish
- Double skin 0.9mm 304 stainless steel interior and exterior
- GN 1/1 4 position racking
- 63mm dia. heavy-duty 1.2mm 304 stainless steel legs with two adjustable feet at front and two rollers at rear

Leg stand (supplied as -LS model)

- Fully modular for matched suite finish
- Framed top for connection to Griddle
- 63mm dia. heavy-duty 1.2mm 304 stainless steel legs with two adjustable feet at front and two rollers at rear
- Fully modular framed stand shelf with 0.9mm 304 stainless steel finish
- Quick assembly design

Controls

- 90-300°C thermostat
- Large easy use control knob - heat resistant reinforced
- Easy view control settings on knob
- Flame failure pilot burner
- Piezo ignition to pilot burner
- Over-temperature safety cut-out

Cleaning and Servicing

- All models with easy clean stainless steel external finish
- Plate is finished front and rear with overlap construction to remove cleaning traps
- Control service and gas conversion through front of unit
- Burner service requires plate removal

GAS GRIDDLE 450mm

GP513-B, GP513-CB, GP513-LS

Specifications

Burner

3 bar chromed steel burner with pilot, flame failure and piezo ignition

Gas power

40MJ/hr, 11.1kW

Plate

Cooking surface 442mm x 530mm, 2343cm²

Gas connection

R 3/4 (BSP) male

All units supplied with Natural and LP gas regulators

Dimensions

Bench model

Weight 77kg

Width 450mm

Depth 812mm

Height 315mm

Incl. splashback 485mm

Cabinet Base / Leg Stand models

Weight 90kg

Width 450mm

Depth 812mm

Height 915mm

Incl. splashback 1085mm

Packing data

Bench model

0.29m³, 111kg

Width 870mm

Depth 495mm

Height 665mm

Cabinet Base / Leg Stand models

0.54m³, 130kg

Width 870mm

Depth 495mm

Height 1255mm

Gas types

Available in Natural gas and LP gas,

please specify when ordering

Units supplied complete with gas type

conversion kits

Other gas types on request

Options

Adjustable feet at rear

Joining caps

Castors

Full width ribbed plate option

Full width mirror chromed plate option

GP513-B

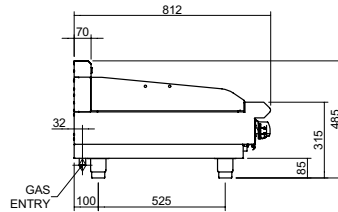
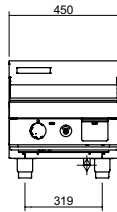

GP513-LS

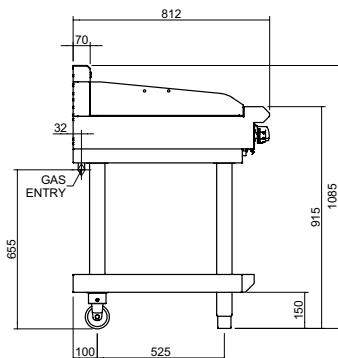
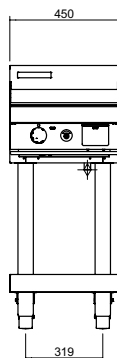

GP513-CB

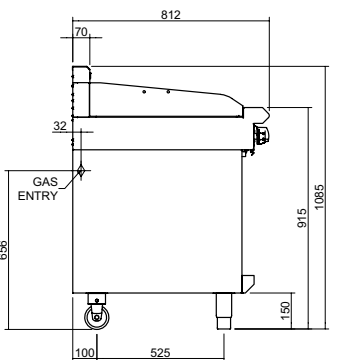
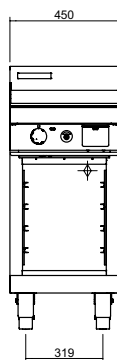

PLAN

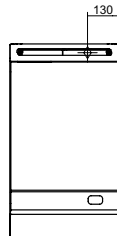

moffat.com.au

moffat.co.nz

Australia

moffat.com.au

Moffat Pty Limited

Victoria/Tasmania
740 Springvale Road
Mulgrave, Victoria 3170
Telephone +613-9518 3888
Facsimile +613-9518 3833
vsales@moffat.com.au

New South Wales
Telephone +612-8833 4111
nswsales@moffat.com.au

South Australia
Telephone +613-9518 3888
vsales@moffat.com.au

Queensland
Telephone +617-3630 8600
qldsales@moffat.com.au

Western Australia
Telephone +618-9413 2400
wasales@moffat.com.au

New Zealand

moffat.co.nz

Moffat Limited

Rolleston
45 Illinois Drive
Izone Business Hub
Rolleston 7675
Telephone +64 3-983 6600
Facsimile +64 3-983 6660
sales@moffat.co.nz

Auckland
Telephone +64 9-574 3150
sales@moffat.co.nz



Cert. No. 6898

In line with policy to continually develop and improve its products, Moffat Limited reserves the right to change specifications and design without notice.

© Copyright Moffat Ltd
AN.BSE.01.19/1620