

LO1UFB

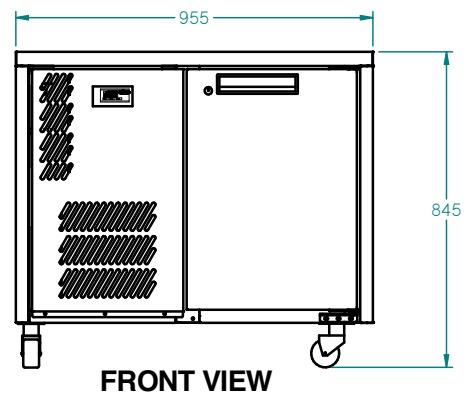

CATEGORY	FOODSERVICE COUNTERS
RANGE	Opal
UNIT	FREEZER
TYPE	SELF CONTAINED
DOORS	1

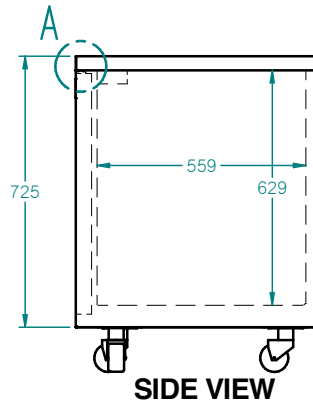
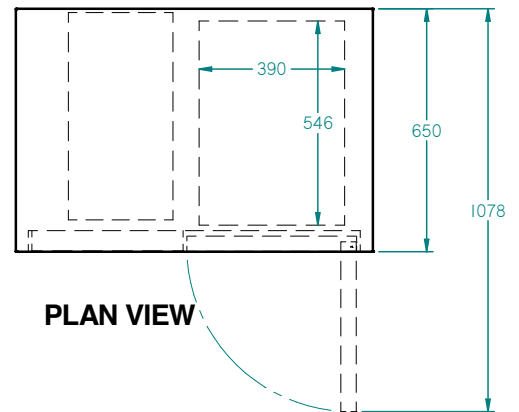

SPECIFICATIONS

CAPACITY LITRES	190
TEMPERATURE	-18°C / -22°C
FRONT BREATHING	YES
DIMENSIONS - W X D X H (ON CASTORS) MM	955 W x 650 D x 845 H
WEIGHT UNPACKED (KG)	100

STANDARD INCLUSIONS ***

DOOR TYPE	Standard: SD (Solid Door) Optional: DR (Drawer)
FINISH (INTERIOR AND EXTERIOR EXCLUDING REAR AND UNDER)	SS (Stainless Steel)
SHELVES/DOOR	2

ELECTRICAL

POWER SUPPLY	10 amp	
FREEZER MODELS	RUNNING AMPS	3.0

GAS TYPE

REFRIGERANT	FREEZER MODELS	R404a
-------------	----------------	-------

*** For **OPTIONS** refer to the current Williams Price Guide