

BC3SS-80

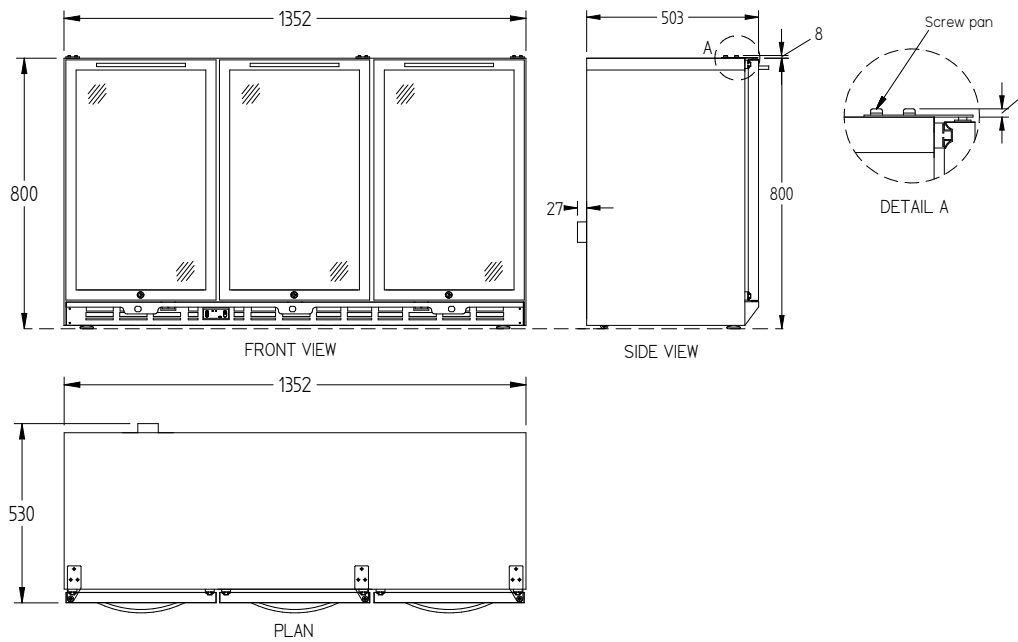

CATEGORY	GENERAL COUNTERS & BACK BARS
RANGE	Bottle Cooler
UNIT	REFRIGERATOR
TYPE	SELF CONTAINED
DOORS	3



SPECIFICATIONS

CAPACITY LITRES	575
TEMPERATURE	1°C / 4°C
DIMENSIONS - W X D X H MM	1352 W x 530 D x 800 H
WEIGHT UNPACKED (KG)	120
DOOR TYPE	Standard: GD (Glass Door)
FINISH (INTERIOR AND EXTERIOR EXCLUDING REAR AND UNDER)	SS (Stainless Steel)
SHELVES/DOOR	2
ELECTRICAL	
POWER SUPPLY	10 amp
FRIDGE MODELS	RUNNING AMPS
	2.4
GAS TYPE	
REFRIGERANT	FRIDGE MODELS
	R134a

*** For **OPTIONS** refer to the current Williams Price Guide