

HQS1GD

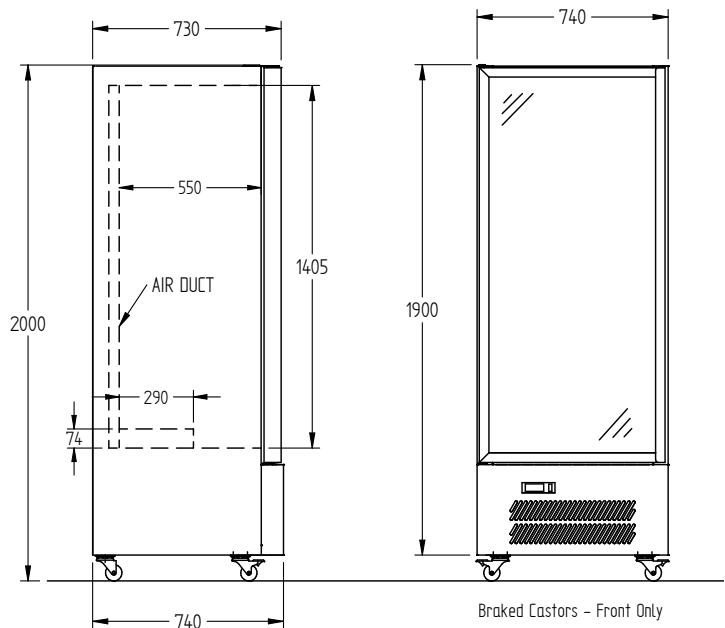

CATEGORY	GENERAL UPRIGHTS
RANGE	Quartz Star
UNIT	REFRIGERATOR
TYPE	SELF CONTAINED
DOORS	1

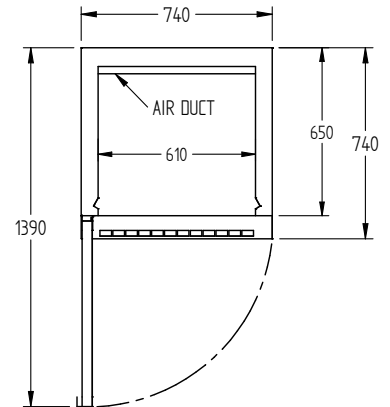

SPECIFICATIONS

CAPACITY LITRES	500
TEMPERATURE	1°C / 4°C
DIMENSIONS - W X D X H (ON CASTORS) MM	740 W x 740 D x 2000 H
WEIGHT UNPACKED (KG)	160

STANDARD INCLUSIONS ***

DOOR TYPE	GD (Glass Door)
FINISH (INTERIOR AND EXTERIOR, EXCLUDES REAR AND UNDER, STAINLESS STEEL INTERNAL FLOOR)	CB (White), CBB (Black), SS (Stainless Steel)
SHELVES/DOOR	4

ELECTRICAL

POWER SUPPLY	10 amp
FRIDGE MODELS - GLASS DOORS	RUNNING AMPS
	3.6

GAS TYPE

REFRIGERANT	FRIDGE MODELS	R134a
-------------	---------------	-------

REFRIGERATION WATTAGES FOR OPTIONAL REMOTE UNITS

FRIDGE MODELS - GLASS DOORS	620 @ -5°C SST
-----------------------------	----------------

*** For **OPTIONS** refer to the current Williams Price Guide